

# RB Series

Collaborative Robot

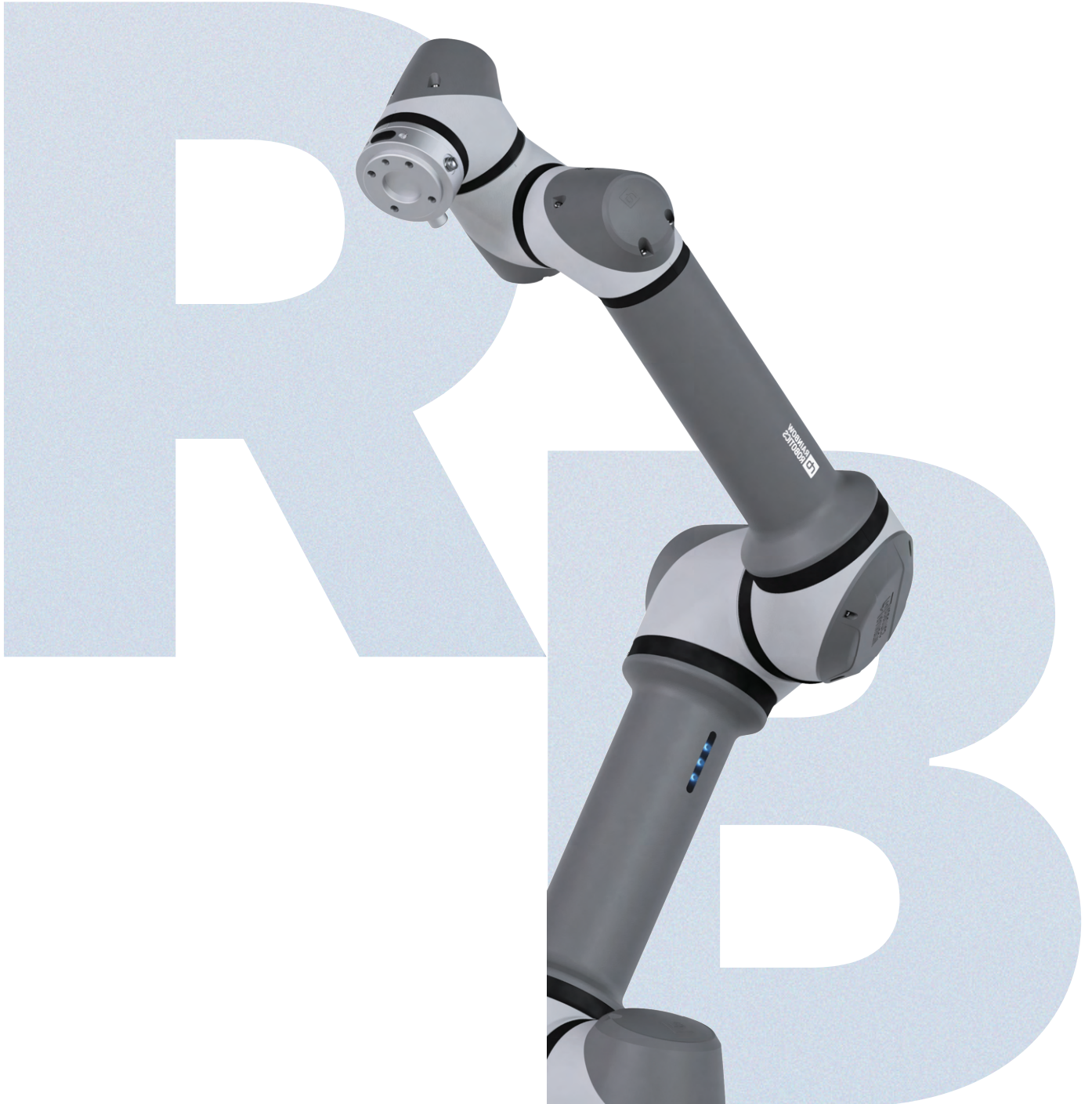



# Company Overview

Rainbow Robotics is a technology-driven, comprehensive robot platform company based in South Korea that develops core robotic components in-house and provides diverse robot platforms and automation solutions. The company has internalized key robotic technologies including precision actuators, control systems, and sensor operating systems, going beyond simple robot supply to offer technology-centered robot platforms to the market. In addition to manufacturing automation, the company is expanding its business into research, education, service, public sector, and special-environment applications, broadening the industrial and societal scope of robot technology.

## 'We touch the core'

Rainbow Robotics will become a company that leads the robotics field with unrivaled technological capabilities.

Founder	Prof. Jun-Ho Oh
CEO	Jung-Ho Lee
Founded	February 10, 2011
IPO Date	February 3, 2021
Headquarters	8, Jiphyeon Jungang 3-ro, Sejong-si, Republic of Korea
AI Research Lab	206, 27 Geumto-ro 80beon-gil, Sujeong-gu, Seongnam-si, Gyeonggi-do
Website	<a href="http://www.rainbow-robotics.com">www.rainbow-robotics.com</a>



# We touch



Korea's Leading Robot Companies

## Rainbow Robotics

### Key Milestones

- |                |  |                |  |
|----------------|--|----------------|--|
| <b>2026.04</b> | Relocation to new headquarters in Sejong Tech Valley       | <b>2024.12</b> | Investment by Samsung Electronics                                |
| <b>2026.02</b> | Opening of Pangyo AI Research Center(2nd Pangyo, Gyeonggi) | <b>2024.09</b> | Contract with Korea Astronomy and Space Science Institute        |
| <b>2026.01</b> | Business restructuring and expansion                       | <b>2024.08</b> | Launch of Mobile Dual-Arm Robot RB-Y Series                      |
| <b>2025.12</b> | Awarded "\$3 Million Export Tower" at the 62nd Trade Day   | <b>2024.03</b> | Supplied collaborative robot drilling automation solution to KAI |
| <b>2025.11</b> | RBQ Series: Korea Top 10 Mech-Tech Winner                  | <b>2023.12</b> | Awarded "\$2 Million Export Tower" at the 60th Trade Day         |
| <b>2025.04</b> | Launch of RBQ quadruped robot AI demonstration project     | <b>2023.04</b> | Establishment of U.S. Sales Corporation (Schaumburg, Illinois)   |
| <b>2025.02</b> | Partnered in Samsung AI Humanoid R&D                       | <b>2023.01</b> | Increased investment from Samsung and subsidiary inclusion       |
| <b>2025.01</b> | Launch of RBM Mobile Robot series                          | <b>2022.12</b> | Awarded "\$1 Million Export Tower" at the 59th Trade Day         |

# the core

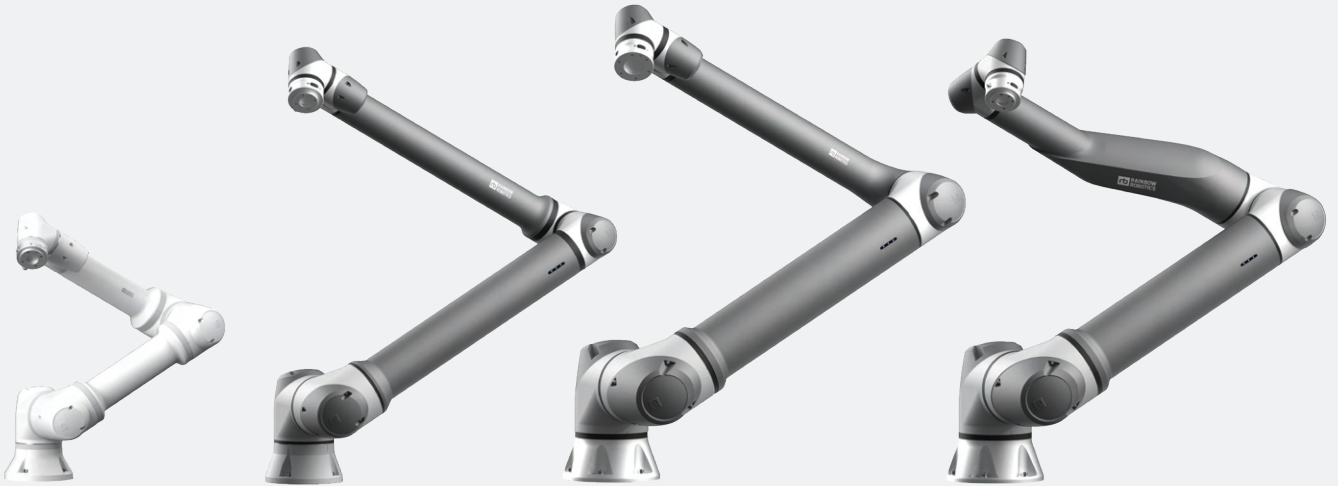

- 2022.10** | 17th Korea Robot Awards - Presidential Commendation
- 2021.03** | RB-N Series NSF Certification (NSF/ANSI 169)
- 2021.02** | Listed on KOSDAQ (277810)
- 2020.08** | Delivery of inner gimbal actuator assembly to LIG Nex1
- 2020.04** | ISO 9001:2015 Quality Management System Certification
- 2019.07** | Launch of Collaborative Robot RB Series
- 2018.02** | PyeongChang 2018 Humanoid Service Provider
- 2017.07** | Venture capital investment of KRW 10 billion
- 2016.04** | Presidential Creation Medal, Science & Technology

- 2016.02** | Delivery of mount & actuator to LIG Nex1
- 2015.12** | Export of DRC-HUBO + to U.S. Naval Research Laboratory
- 2015.09** | KASI Space Surveillance Mount Operation
- 2015.06** | 1st place at DARPA Robotics Challenge Finals
- 2014.01** | Venture company certification
- 2013.09** | Export of HUBO II to Google Inc. USA
- 2011.12** | Export of HUBO II to MIT et al, supported by U.S. NSF
- 2011.05** | Establishment of corporate research institute
- 2011.02** | Founded as Rainbow Co., Ltd. (now Rainbow Robotics Co., Ltd.)

\*KOSDAQ : Trading board of Korea Exchange (KRX)  
in South Korea established in 1996.

## Collaborative robots

# RB Series

Our RB series features 6-axis collaborative robot arms engineered with the expertise we've cultivated since the first generation of commercial robots. We offer six models with payload and reach ranging from 3-20 kg (6.6-44 lbs) and 730-1900 mm (29-75 in). All our cobots undergo rigorous testing and are certified by TÜV SÜD to meet global standards:

- ISO 13849-1, Cat.3, PL d
- ISO 10218-1
- ISO/TS 15066
- NSF/ANSI 169
- NRTL(UL 1740), CSA(Z434)



### RB Series Line

RB3-730

RB5-850

RB16-900

RB3-1200

RB10-1300

RB6-1700

RB20-1800

RB20-1900

RB30-1400

## Key Features



### In-House Components: Superior Performance, Competitive Pricing

Rainbow Robotics develops and uses core components required in its cobots, such as actuators, encoders, brakes, and controllers, in-house. With these components, RB series can deliver high driving speeds, precise controls, and braking performance without any play or instability in the braking system. Moreover, RB series is much more reasonably priced than the competition (30% cheaper) thanks to Rainbow Robotics' extensive use of in-house developed parts.

#### Key components of the collaborative robots developed by Rainbow Robotics

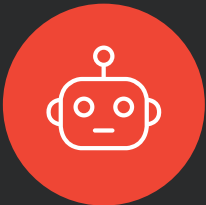
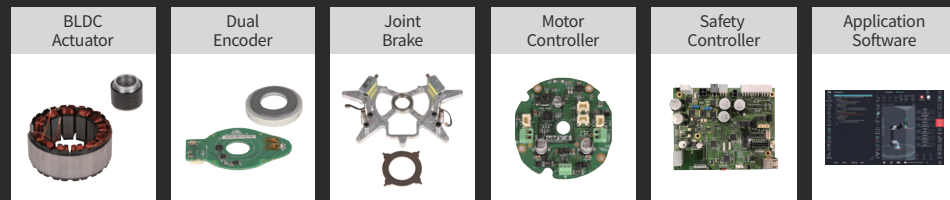

### Cobot Technology from Humanoid Robotics Experts

Rainbow Robotics is the pioneering company behind HUBO, an extraordinary bipedal robot renowned for its cutting-edge robotics technology. Leveraging its expertise in humanoid robotics, Rainbow Robotics has developed RB series, a dedicated line of cobots. Each cobot in RB series is equipped with advanced features, including a collision detection system, a gravity compensation device, and a sophisticated motor control system.



### Easy Software Interface

RB series is powered by a Linux-based, real-time robot operating system developed independently by Rainbow Robotics. The operating system uses a supervisory control algorithm to oversee and optimize the performance of each cobot. It supports the precise execution of tasks within a predictable time range.

This enables smooth movement and reduces the time required for each move or action. Additionally, Rainbow Robotics can address any issues with a software update if a cobot requires additional functions or upgrades to its system operations.

# RB3-730

RB3-730 is a compact, high-precision model with a payload capacity of 3 kg (6.6 lbs) and a maximum reach of 730 mm (28.7 inches). Featuring S-pipe joint arrangements, RB3-730 excels in executing contour motions frequently used in welding and bonding processes. Efficient motion can be created because the rotation axes of the three wrist joints pass through a single point. It is ideal for applications in IT, electronics, welding, and bio services.

Specification	
Payload	3 kg / 6.6 lbs
Reach	730 mm / 28.7 in
Repeatability	± 0.05 mm
Footprint / Angle	∅ 128 mm / any direction
Material	Aluminum, plastic, steel
Tool connector type	M8 8-pin connector 2EA (12/24V, ~2A) Power, Din 6 port (PNP), Dout 2 port (PNP), MBus RTU EN ISO 9409-1-50-4-M6
Cable length	5 m / 196.8 in (Customizable)
Weight	11 kg / 24.3 lbs
Operating environment	IP54 / 0-50 °C / 32–122 °F (≤90% RH non-condensing)
Power consumption	100W with the ordinary program
Noise	Less than 60dB(A)
Joint range & Max. speed	J1 : ± 360 °      ± 180 °/s
	J2 : ± 360 °      ± 180 °/s
	J3 : ± 150 °      ± 180 °/s
	J4 : ± 360 °      ± 180 °/s
	J5 : ± 360 °      ± 360 °/s
	J6 : ± 360 °      ± 360 °/s
Typical TCP speed	1m/s

\* Specifications may change to improve performance.



# RB5-850

With a 5 kg load capacity and an 927.7 mm reach, RB5-850 is the standard model of RB series. It is suitable for manufacturing tasks like production, assembly, and fastening, as well as service tasks in food and beverage systems, disinfection/sanitizer systems, and robot studios.

Specification	
Payload	5 kg / 6.6 lbs
Reach	927.7 mm / 36.5 in
Repeatability	± 0.05 mm
Footprint / Angle	∅ 173 mm / any direction
Material	Aluminum, plastic, steel
Tool connector type	M8 8-pin connector 2EA (12/24V, ~2A) Power, Din 6 port (PNP), Dout 2 port (PNP), MBus RTU EN ISO 9409-1-50-4-M6
Cable length	5 m / 196.8 in (Customizable)
Weight	22 kg / 48.5 lbs
Operating environment	IP54 / 0-50 °C / 32–122 °F (≤90% RH non-condensing)
Power consumption	200W with the ordinary program
Noise	Less than 65dB(A)
Joint range & Max. speed	J1 : ± 360 °      ± 180 °/s
	J2 : ± 360 °      ± 180 °/s
	J3 : ± 165 °      ± 180 °/s
	J4 : ± 360 °      ± 180 °/s
	J5 : ± 360 °      ± 180 °/s
	J6 : ± 360 °      ± 180 °/s
Typical TCP speed	1m/s

\* Specifications may change to improve performance.



# RB16-900

With a 16 kg payload and a 900 mm reach, RB16-900 is a great option for handling heavy objects in tight spaces like packaging and CNC loading.

Specification	
Payload	16 kg / 35.3 lbs
Reach	900 mm / 35.4 in
Repeatability	± 0.05 mm
Footprint / Angle	∅ 196 mm / any direction
Material	Aluminum, plastic, steel
Tool connector type	M8 8-pin connector 2EA (12/24V, ~2A) Power, Din 6 port (PNP), Dout 2 port (PNP), MBus RTU EN ISO 9409-1-50-4-M6
Cable length	5 m / 196.8 in (Customizable)
Weight	35.5 kg / 78.26 lbs
Operating environment	IP54 / 0-50 °C / 32–122 °F (≤90% RH non-condensing)
Power consumption	350W with the ordinary program
Noise	Less than 65dB(A)
Joint range & Max. speed	J1 : ± 360 °     ± 120 °/s J2 : ± 360 °     ± 120 °/s J3 : ± 165 °     ± 180 °/s J4 : ± 360 °     ± 180 °/s J5 : ± 360 °     ± 180 °/s J6 : ± 360 °     ± 180 °/s
Typical TCP speed	1m/s

\* Specifications may change to improve performance.



# RB3-1200

RB3-1200 has a 3 kg payload and a 1,200 mm range, offering the largest working radius among small-load cobots. It performs complex tasks like welding, grinding, and CNC machine tending, and can be used with an autonomous mobile robot (AMR).

Specification	
Payload	3 kg / 6.6 lbs
Reach	1200 mm / 47.2 in
Repeatability	± 0.05 mm
Footprint / Angle	∅ 173 mm / any direction
Material	Aluminum, plastic, steel
Tool connector type	M8 8-pin connector 2EA (12/24V, ~2A) Power, Din 6 port (PNP), Dout 2 port (PNP), MBus RTU EN ISO 9409-1-50-4-M6
Cable length	5 m / 196.8 in (Customizable)
Weight	22.4 kg / 49.3 lbs
Operating environment	IP66 / 0-50 °C / 32–122 °F (≤90% RH non-condensing)
Power consumption	200W with the ordinary program
Noise	Less than 65dB(A)
Joint range & Max. speed	J1 : ± 360 °     ± 180 °/s J2 : ± 360 °     ± 180 °/s J3 : ± 165 °     ± 180 °/s J4 : ± 360 °     ± 180 °/s J5 : ± 360 °     ± 180 °/s J6 : ± 360 °     ± 180 °/s
Typical TCP speed	1m/s

\* Specifications may change to improve performance.



# RB10-1300

With a 10 kg payload and a maximum reach of 1,300 mm, RB10-1300 is effective for tasks involving heavier objects such as packaging, CNC loading, and pallet loading.

Specification	
Payload	10 kg / 22 lbs
Reach	1300 mm / 51.2 in
Repeatability	± 0.05 mm
Footprint / Angle	∅ 196 mm / any direction
Material	Aluminum, plastic, steel
Tool connector type	M8 8-pin connector 2EA (12/24V, ~2A) Power, Din 6 port (PNP), Dout 2 port (PNP), MBus RTU EN ISO 9409-1-50-4-M6
Cable length	5 m / 196.8 in (Customizable)
Weight	36.5 kg / 80.47 lbs
Operating environment	IP66 / 0-50 °C / 32-122 °F (≤90% RH non-condensing)
Power consumption	200W with the ordinary program
Noise	Less than 65dB(A)
Joint range & Max. speed	J1 : ± 360 °      ± 120 °/s J2 : ± 360 °      ± 120 °/s J3 : ± 165 °      ± 180 °/s J4 : ± 360 °      ± 180 °/s J5 : ± 360 °      ± 180 °/s J6 : ± 360 °      ± 180 °/s
Typical TCP speed	1m/s

\* Specifications may change to improve performance.



# RB6-1700

With a 6kg payload and a 1,700mm reach, the RB6-1700 is designed to handle transfer, picking, and sorting across multiple stations with a single robot. Its 6kg capacity and IP66-rated durability ensure stable operation even in demanding environments, such as food, logistics, packaging, and electronics manufacturing.

Specification	
Payload	6 kg / 13.2 lbs
Reach	1700 mm / 66.9 in
Repeatability	± 0.05 mm
Footprint / Angle	∅ 196 mm / any direction
Material	Aluminum, plastic, steel
Tool connector type	M8 8-pin connector 2EA (12/24V, ~2A) Power, Din 6 port (PNP), Dout 2 port (PNP), MBus RTU EN ISO 9409-1-50-4-M6
Cable length	5 m / 196.8 in (Customizable)
Weight	39 kg / 86 lbs
Operating environment	IP66 / 0-50 °C / 32-122 °F (≤90% RH non-condensing)
Power consumption	350 W with the ordinary program
Noise	Less than 65dB(A)
Joint range & Max. speed	J1 : ± 360 °      ± 120 °/s J2 : ± 360 °      ± 120 °/s J3 : ± 165 °      ± 180 °/s J4 : ± 360 °      ± 180 °/s J5 : ± 360 °      ± 180 °/s J6 : ± 360 °      ± 180 °/s
Typical TCP speed	1m/s

\* Specifications may change to improve performance.



# RB20-1800

With a 20kg payload and 1,800mm reach, the RB20-1800 is optimized for heavy-duty tasks in tight spaces, including packaging and CNC machine tending.

Specification	
Payload	20 kg / 44 lbs
Reach	1800 mm / 70.8 in
Repeatability	± 0.05 mm
Footprint / Angle	Ø 245 mm / any direction
Material	Aluminum, plastic, steel
Tool connector type	M8 8-pin connector 2EA (12/24V, ~2A) Power, Din 6 port (PNP), Dout 2 port (PNP), MBus RTU EN ISO 9409-1-80-6-M8
Cable length	5 m / 196.8 in (Customizable)
Weight	70.5 kg / 155.4 lbs
Operating environment	IP66 / 0-50 °C / 32-122 °F (≤90% RH non-condensing)
Power consumption	500 W with the ordinary program
Noise	Less than 65dB(A)
Joint range & Max. speed	J1 : ± 360 °     ± 120 °/s J2 : ± 360 °     ± 120 °/s J3 : ± 165 °     ± 120 °/s J4 : ± 360 °     ± 120 °/s J5 : ± 360 °     ± 180 °/s J6 : ± 360 °     ± 180 °/s
Typical TCP speed	2m/s

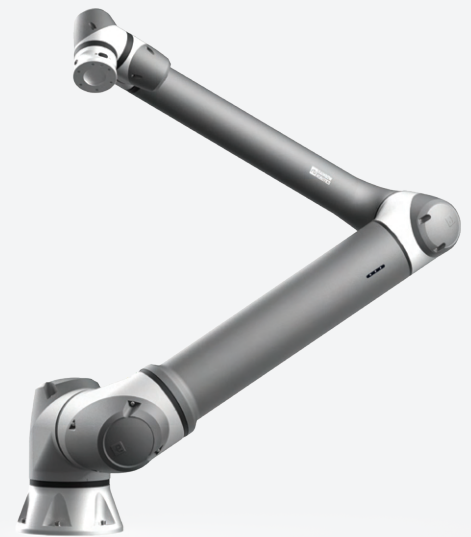

# RB20-1900

With a 20 kg payload and a 1,900 mm reach, RB20-1900 handles the heaviest loads in RB series. It is effective for packaging and palletizing. Thanks to its sufficient power capacity, RB20-1900 can be installed in any orientation, including on the floor or on a wall.

Specification	
Payload	20 kg / 44 lbs
Reach	1900 mm / 74.8 in
Repeatability	± 0.05 mm
Footprint / Angle	Ø 245 mm / any direction
Material	Aluminum, plastic, steel
Tool connector type	M8 8-pin connector 2EA (12/24V, ~2A) Power, Din 6 port (PNP), Dout 2 port (PNP), MBus RTU EN ISO 9409-1-50-4-M6
Cable length	5 m / 196.8 in (Customizable)
Weight	75 kg / 165.3 lbs
Operating environment	IP66 / 0-50 °C / 32-122 °F (≤90% RH non-condensing)
Power consumption	500 W with the ordinary program
Noise	Less than 65dB(A)
Joint range & Max. speed	J1 : ± 360 °     ± 120 °/s J2 : ± 360 °     ± 120 °/s J3 : ± 150 °     ± 120 °/s J4 : ± 360 °     ± 120 °/s J5 : ± 360 °     ± 180 °/s J6 : ± 360 °     ± 180 °/s
Typical TCP speed	2m/s



\* Specifications may change to improve performance.

# RB30-1400

The RB30-1400 is a collaborative robot offering a 30kg payload and a 1,400mm reach, specifically designed for stable heavy-part handling and industrial automation. Featuring high torque and a robust joint structure, it delivers superior productivity and safety in demanding environments such as machining, machine tending, and part transfer.

Specification	
Payload	30 kg / 66.1 lbs
Reach	1400 mm / 55.1 in
Repeatability	± 0.05 mm
Footprint / Angle	Ø 245 mm / any direction
Material	Aluminum, plastic, steel
Tool connector type	M8 8-pin connector 2EA (12/24V, ~2A) Power, Din 6 port (PNP), Dout 2 port (PNP), MBus RTU EN ISO 9409-1-80-6-M8
Cable length	5 m / 196.8 in (Customizable)
Weight	71 kg / 158 lbs
Operating environment	IP66 / 0-50 °C / 32-122 °F (≤90% RH non-condensing)
Power consumption	500 W with the ordinary program
Noise	Less than 65dB(A)
Joint range & Max. speed	J1 : ± 360 °     ± 120 °/s J2 : ± 360 °     ± 120 °/s J3 : ± 150 °     ± 120 °/s J4 : ± 360 °     ± 120 °/s J5 : ± 360 °     ± 180 °/s J6 : ± 360 °     ± 180 °/s
Typical TCP speed	1m/s



## Plug N Play I/O Extension Module

RB series has a total of 40 I/O ports (default configuration). If more I/O ports are required, with RB's I/O extension module, users can add ports without using additional equipment, such as a PLC.



Specification	
I/O ports	Digital input 16 (PNP)
	Digital output 16 (PNP)
	Analog input 4 (0-10V)
	Analog output 4 (0-10V)
Power source	100-240V AC, 50-60 Hz
Size	403 x 313 x 110mm
Weight	500g
Materials	Aluminum

\* Specifications may change to improve performance.

# Robot Control Box

Robot control box manages arm movements based on user programs. It has digital and analog input/output ports and various industrial communication features for connecting various devices.

\*Light-duty model

## Standard Control Box (CB06)

\*Please contact us for information on CB06-1 certified and heavy-duty models. RB20-1900ES / RB30-1400ES / RB20-1800E series

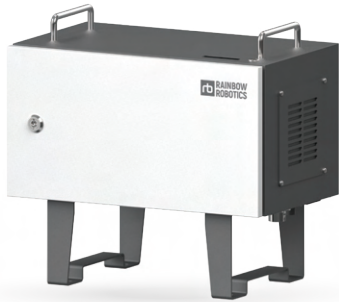

\*Light-duty model

## Small Control Box (CB07)



\*Light-duty model

## DC Control Box (CB09)



Specification	
I/O ports	Digital input 16 (PNP) Digital output 16 (PNP) Analog input 4 (0-10V) Analog output 4 (0-10V) USB (4 ports), LAN (RJ45 1 port) Ethernet (TCP/IP, MODBUS TCP, Control Script) Siemens S7, OMRON Fins, Mitsubishi MC, EtherNet/IP, ProfiNet, OPC-UA, etc * I/O expansion modules available
Power source	100-240V AC, 50-60 Hz Single Phase
Dimension	443 x 260 x 371 mm / 17.4 x 10.2 x 14.6 in : Main body 443 x 260 x 411 mm / 17.4 x 10.2 x 16.2 in : Handle included
Weight	15 kg / 33 lbs
Material	Electro galvanized (EG) steel
Certified	RB5-850E / RB3-1200E / RB10-1300E / RB16-900E / RB6-920ES / RB6-1700E series
uitable model	RB5-850E / RB3-1200E / RB10-1300E / RB16-900E / RB6-920ES / RB6-1700E / RB3-730ES series

Specification	
I/O ports	Digital input 16 (PNP) Digital output 16 (PNP) Analog input 4 (0-10V) Analog output 4 (0-10V) USB (4 ports), LAN (RJ45 1 port) Ethernet (TCP/IP, MODBUS TCP, Control Script) Siemens S7, OMRON Fins, Mitsubishi MC, EtherNet/IP, ProfiNet, OPC-UA, etc * I/O expansion modules available
Power source	100-240V AC, 50-60 Hz Single Phase
Dimension	420 x 232 x 173.5 mm / 16.5 x 9.1 x 6.8 in : Main body 460 x 232 x 173.5 mm / 18.1 x 9.1 x 6.8 in : Handle included
Weight	8.3 kg / 18.3 lbs
Material	SUS 304
Certified model	RB3-730ES / RB6-920E series
Suitable model	RB5-850E / RB3-1200E / RB10-1300E / RB16-900E / RB6-920ES RB6-1700E / RB3-730ES series

Specification	
I/O ports	Digital input 16 (PNP) Digital output 16 (PNP) Analog input 4 (0-10V) Analog output 4 (0-10V) USB (4 ports), LAN (RJ45 1 port) Ethernet (TCP/IP, MODBUS TCP, Control Script) Siemens S7, OMRON Fins, Mitsubishi MC, EtherNet/IP, ProfiNet, OPC-UA, etc * I/O expansion modules available
Power source	48VDC(36~72VDC)
Dimension	420 x 232 x 173.5 mm / 16.5 x 9.1 x 6.8 in : Main body 470 x 232 x 173.5 mm / 18.5 x 9.1 x 6.8 in : Handle included
Weight	7.8 kg / 17.2 lbs
Material	SUS 304
Certified model	RB5-850E / RB10-1300E / RB16-900E / RB3-730ES series
Suitable model	RB5-850E / RB3-1200E / RB10-1300E / RB16-900E / RB6-920ES / RB6-1700E / RB3-730ES series

\* Specifications may change to improve performance.

# Certifications

## 1. RB Series

- Safety certified (CE, NRTL, KCs) through global certification body TÜV SÜD, ensuring robot stability (ISO 13849-1, PL d, Cat.3, and ISO 10218-1, ISO/TS 15066)
- Quality assurance systematized and proceduralized through Quality Management System certification (ISO 9001)



Cert. Type	Product	Applied Standards	Certifying Body	
NRTL/CSA	Motor, drive-	UL 61800-5-1:2012/R:2021-02 CSA C22.2 No. 274:2017	TÜV SÜD	
	Industrial Robot	CSA Z434:2014 UL 1740:2018/R:2020-11 NFPA 79:2021		
CE AOC	Motor, drive-	EN 61800-5-1:2007/A1:2017		
	Industrial Robot EMCD	EN 61000-3-2:2014 EN 61000-3-3:2013 EN 61000-3-3:2013/A1:2019 EN 61000-6-2:2005 EN 61000-6-4:2007/A1:2011 EN IEC 61000-3-2:2019		
		EN 61000-3-2:2014 EN 61000-3-3:2013 EN 61000-3-3:2013/A2:2021 EN 61000-6-2:2005 EN 61000-6-4:2007/A1:2011 EN IEC 61000-3-2:2019/A1:2021		
Industrial Robot MD	EN 60204-1:2018 EN ISO 10218-1:2011 EN ISO 12100:2010 Machinery Directive 2006/42/EC			
Functional Safety	Robot Safety Unit	IEC 61508-1:2010 (SIL 2) IEC 61508-2:2010 (SIL 2) IEC 61508-3:2010 (SIL 2) EN 62061:2005/A2:2015 (SILCL 2) EN ISO 13849-1:2015 (Cat. 3, PL d) EN ISO 10218-1:2011 ISO TS 15066:2016 IEC 61800-5-2:2016		
KCs (Autonomous Safety Confirmation)	Industrial Robot	-		Korea Occupational Safety and Health Agency

# Why RB Series?

## Robust Aluminum Construction

Our cobots' aluminum bodies are ideal for polishing, processing, and welding. With the durable and light hardware, robot can perform reliably in tough manufacturing environments.



## Industry-leading IP Rating

RB Series Cobots offer best-in-class IP ratings (IP66). Cobots can take on more diverse roles at CNC machining sites, food and beverage sites, etc.

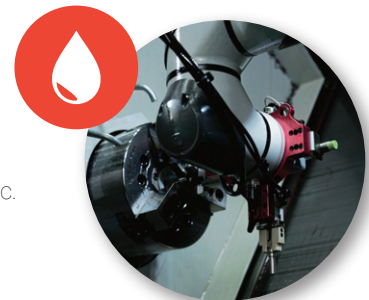

## Safety System

Safety is one of the main reasons for using collaborative robots. RB Series collaborative robots ensure the safety of users and robots through four key features.

- External force collision detection
- Vibration detection
- Self-collision prevention
- Safe plane and range settings



## Certified & Tested

Our cobots are verified by TÜV SÜD for its safety and performance reliability. They meet global safety standards and are trusted by users worldwide.



## Versatile built-in Features

RB Series offers numerous built-in features. Immediately deploy RB Cobot into various applications without additional programming or costs.



# Convenient Program View

Rainbow Robotics provides an intuitive and progressive proprietary UI. Deploy your automation project with just a few clicks through the touch screen / monitor. Convenient program creation increases your productivity and reduces the time and cost required for program management.

By utilizing industry-leading built-in functions, RB series robots can be quickly deployed into automation sites without additional costs.

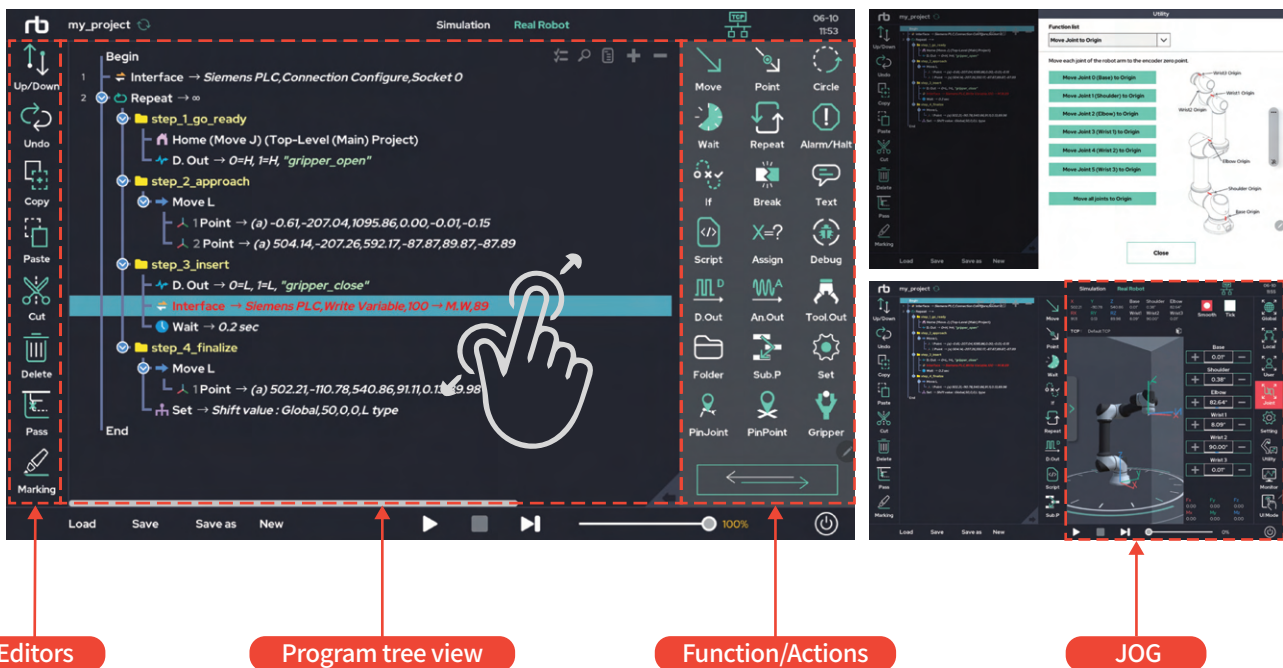

# Versatile Jog

User can manipulate the robot arm based on various coordinate systems. Robot moves based on the coordinate system selected by the user. By using Tick Mode, user can adjust the interval as desired. User can also operate the robot using the Hand-Guiding (Free-Drive) function through the button attached to the end of the robot.

Experience advanced hand-guiding function that moves the robot arm by constraining specific plane or direction.

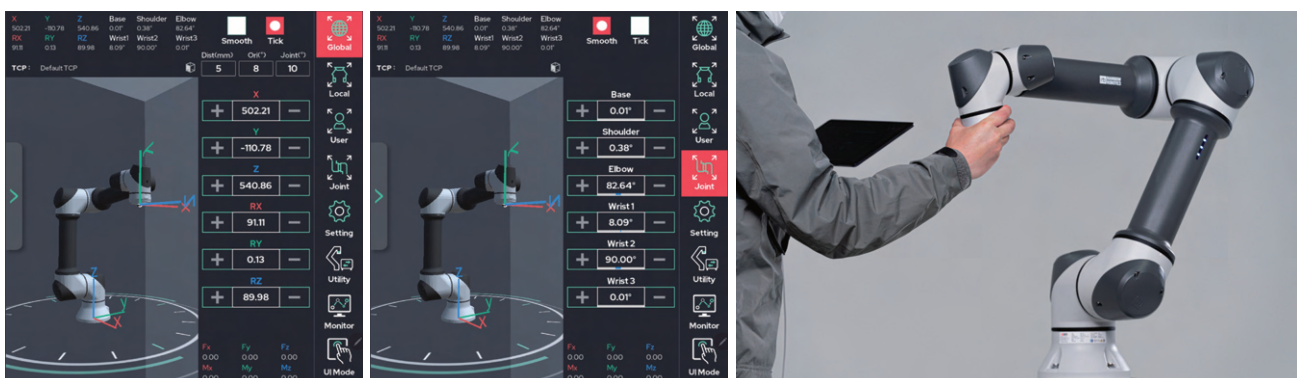

# Easy I/O Management

RB Series provide a variety of options for controlling the most frequently used input/output signals in the field. It provides various options such as simple output, pulse output, bit combination output, and delayed output, allowing you to control signals without separate coding.

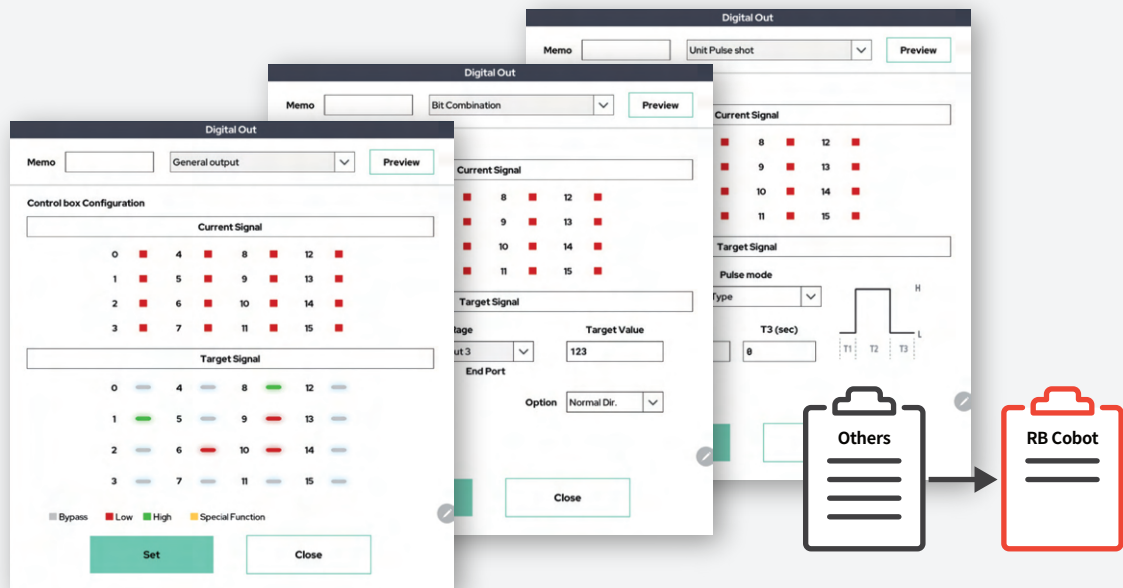

# Multi-Processing

To cope with various automation sites, one main program pipeline and four parallel pipelines are provided. In addition, it provides a program management tool such as [SubProgram], [ProgramConvert], [Template], allowing you to manage projects efficiently and safely.



- Thread
- Event Thread
- Sub Program
- Template
- Program Conversion

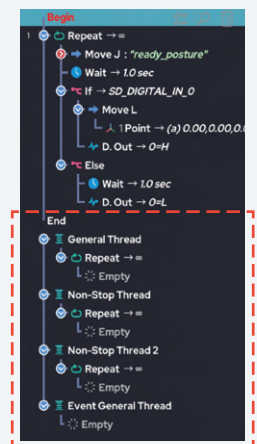

# Configurable System I/O

To ensure a smooth system configuration with PLC and peripheral devices, there are over 100 various system management I/O functions. Designated functions are performed and managed in the background without separate programming.

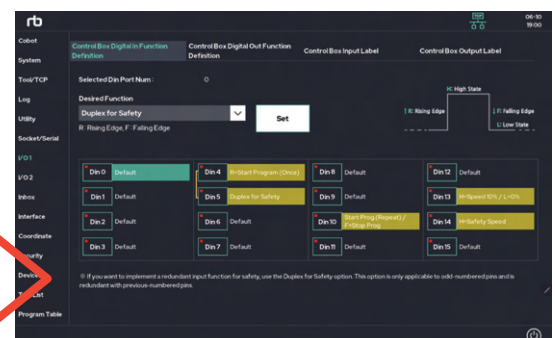
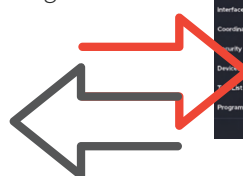

# Polishing & Grinding

Users are free from harsh polishing/painting environments. Using Rainbow's features, you can easily implement repeated actions. We provide the best solution for creating repetitive and patterned robot trajectories such as polishing/painting.

By using functions such as [Motion macros] and [Pattern], users are free from repeated robot teaching. Even if the object changes, user can respond quickly by just changing a few landmark points. Don't waste any more time teaching repetitive movements.

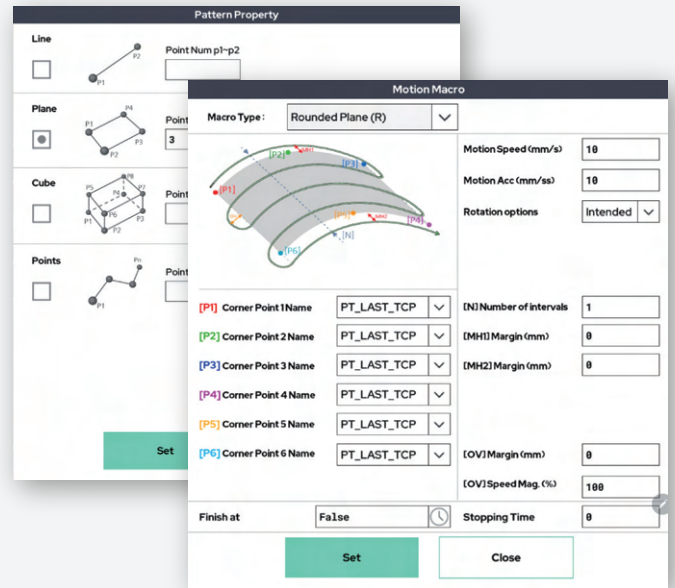

# Intelligent Force Control

Rainbow Robotics' collaborative robots feature a built-in force control function. User can easily implement force control by connecting them to various Force/Torque sensors (Hardware is add-on option). RB robots are capable of performing surface treatments such as grinding and polishing with constant force.

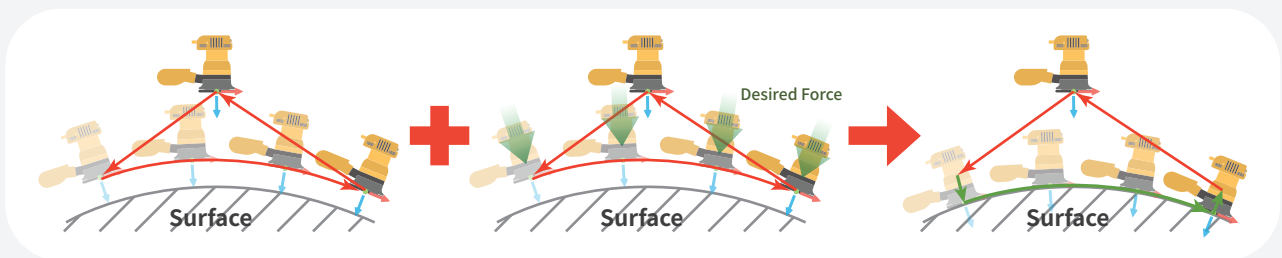

# Easy 3D Modeling Simulation

Users can load a 3D modeling file designed for the project environment into the UI and virtually review the robot's path and workability.

In addition, Rainbow Robotics also supports Third Party OLPs, such as RoboDK, Visual Components, Octopuz, ROS.

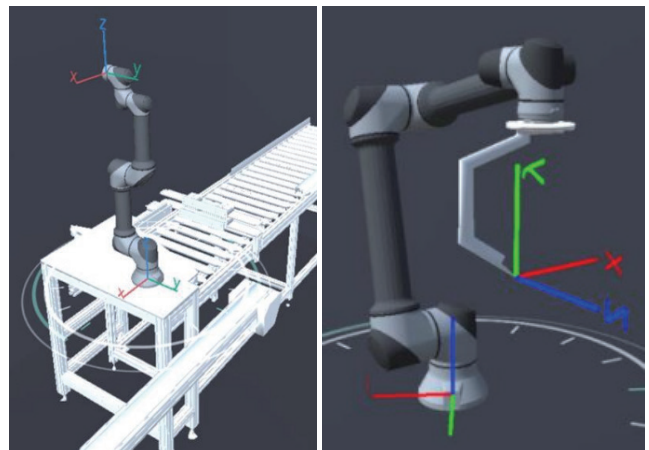

# Teaching Pendant

Rainbow Robotics' cobots are easy to program using the Rainbow Robotics Teaching Pendant. Moreover, the icon-based GUI allows users to configure the interface to suit their required conditions. The user-friendly GUI also makes maintenance easier, improves security, and enables intuitive programming. Teaching Pendant is compatible with Android OS-based smartphones, tablet PCs, and Windows OS-based devices.

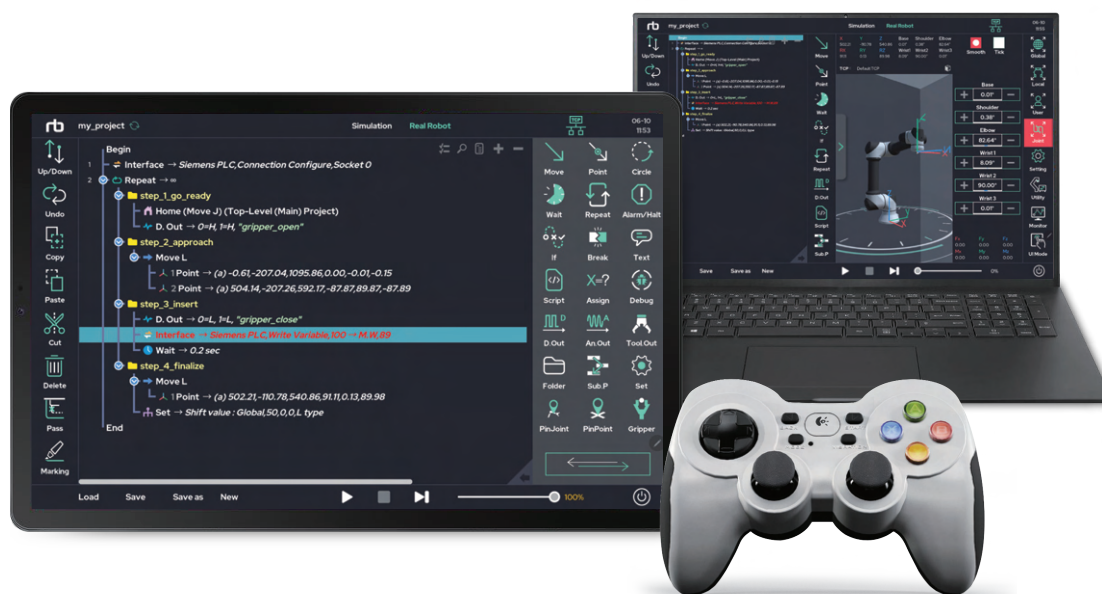

## ◆ Main Features



### User's Convenience

Rainbow Robotics' Teaching Pendant is a lightweight, highly responsive product, and it can be connected via wired or wireless options. Also, a single Teaching Pendant can control multiple robots.



### Program Configuration

Users can confirm and load previously created programs through the SubProgram and Template functions. When a program is loaded, it is automatically grouped, allowing users to easily view the full overview.



### Jog-based Interface

When writing a program, a robot often has to be repositioned or relocated. The RB series cobots have a jog dial located next to the programming window. Users can use the jog dial to move the robot and add the desired commands.



### Flexible Digital Output

Users can control the entire port by selecting either ON or OFF. Furthermore, various options such as a bit combination output and pulse output are available for digital output.



### Organized Program Management

Users can access the program summary through the program tree, and functions such as zoom/scroll can help view the content with greater accuracy.



### Real-time Monitoring

Teaching Pendant features debugging and monitoring functions to check the value of selected variables. While the program is running, users can view the selected variable via a pop-up and monitor variables in real-time.

# Built-In Functionality

Rainbow Robotics' RB Series has various built-in functions for users. Experience a variety of motion creation functions, communication functions, and program management functions without installation and extra cost.



## Robot Arm Movement

Move J, Move L, Move JB, Move LB, Move PB, Move JL, Move ITPL, Move Pro, Move XB, Circle, Home



## Program Logic Flow

Wait, if/else, Repeat, Break, Continue, Switch, Halt, Jump, Pre-Program, Post-Program, Thread, Sub-Program, Convert



## User Programming

Assign, Script, Debug, Monitoring, Memo, Alarm, User Input, User Log, Folder



## Advanced Motion Generation

Pattern, Weaving, TCP-Weaving, Conveyor, Force-Control, Motion Macro, RePlay, G-Code, Pin-Point, Pin-Joint



## Welding Application

ArcWelder On/Off, Digital Welder On/Off, ArcSensing, TouchSensing



## I/O Control Function

Digital Out, Analog Out, Extension I/O Control, Tool-Flange Out, Gripper



## Communication

Interface, TCP/IP Socket, Serial, Modbus, EtherNet/IP, ProfiNet, OPC-UA



## Others

Set, TCP-Set, Manual Driving, External Axis

# Start your Welding with single line

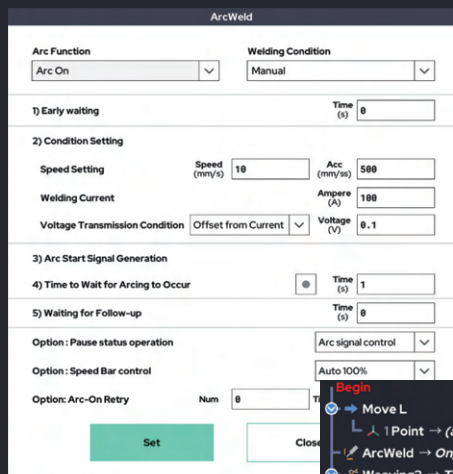

Collaborative robot welding is growing. To implement welding, users only need to use a single On/Off command. When you enter the desired welding conditions (current/voltage/speed), RB Cobot takes care of the necessary calculations and communication. Don't waste any more time for programming. Various welding machines are also linked. Most welders with an analog interface (Miller, Fronius, Daihen, Megmeet, etc) as well as welders with a digital communication interface (ESAB, Kemppi, KOLARC, Hyundai, etc) can be used immediately with just one line. Rainbow collaborative robots are used in various welding fields such as MIG/TIG/Laser.

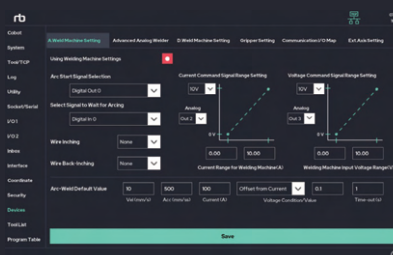

## Various Weaving Profiles

Weaving action cannot be omitted in welding. In our RB UI, various weaving shapes (profiles) are built-in. Built-in trapezoidal, triangle wave, sine wave, square wave, wave pattern, circular shape, etc. Users can easily implement weaving welding by entering the desired type and parameters. No more wasting time programming to implement weaving.

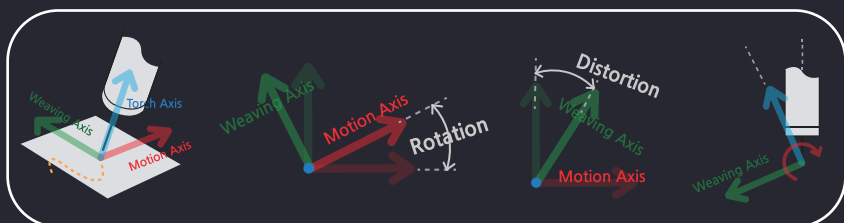

## Built-In Arc-Sensing



RB Series has built-in seam tracking functionality through arc sensing (current sensing). Through this function, robot can automatically track the center line of the weld while weaving and automatically adjust the height of the wire. It can be applied in a variety of ways, such as MIG/TIG welding.

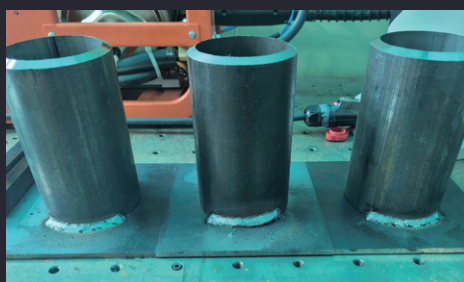

# Infinite Connectivity

Communication with various equipment is required in automation sites. Using Rainbow collaborative robots, you can easily communicate with various parallels such as PLC, HMI, and sensors.

\* The intellectual property rights for the product images and logos used in this promotional material belong to the respective manufacturers.

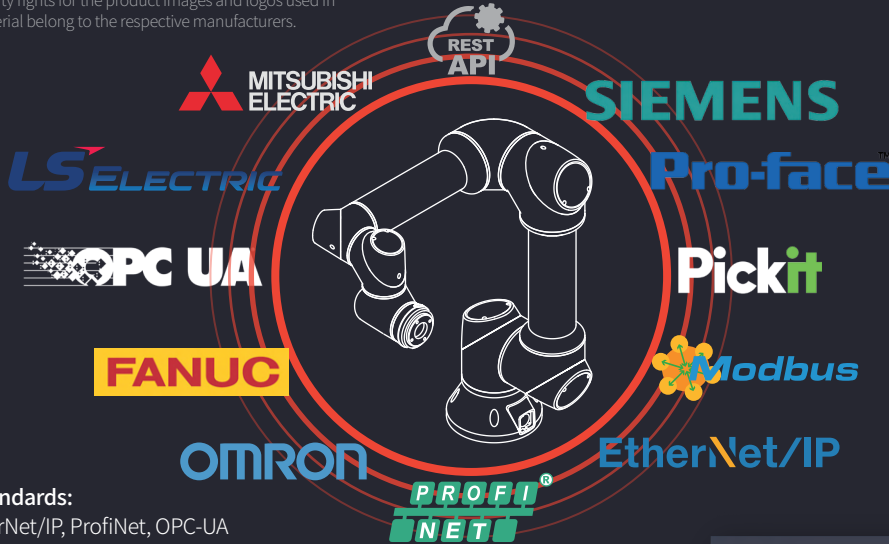

- **International standards:**  
ModbusTCP, EtherNet/IP, ProfiNet, OPC-UA
- **Manufacturer designated:**  
FINS (OMRON), S7 (Siemens), MC (Mitsubishi), XGT (LS), MemoryLink (Proface HMI), Focas (FANUC)
- **General:**  
TCP/IP Socket, RS232/485

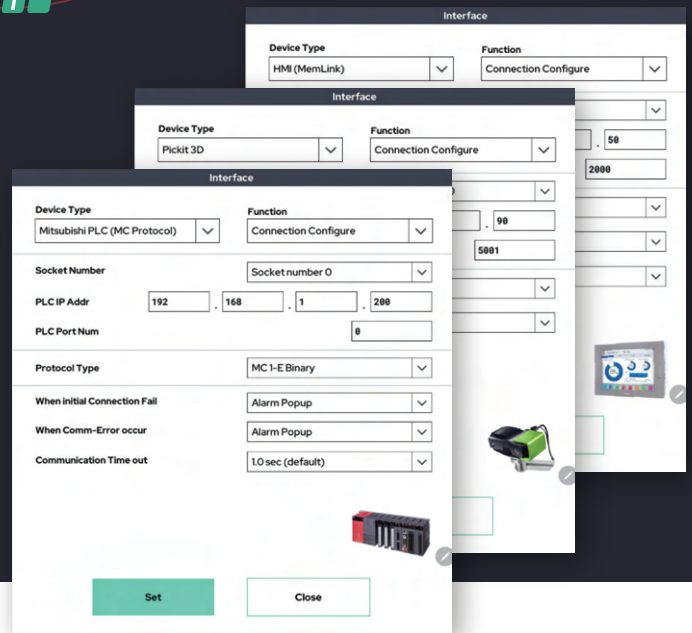
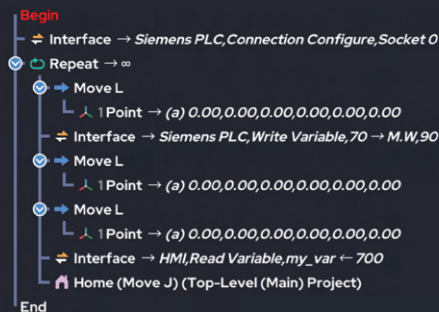

# Customizable Hand Controller

RB Series collaborative robots come with a hand controller. User can use it by setting the desired function to the function keys of the hand controller. Increase the usability of the collaborative robot through the buttons on the hand controller without making separate buttons.

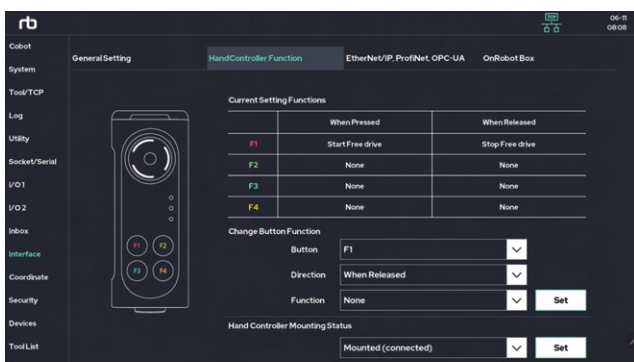

# Achieve your automation without PLC

RB Series provides various features and functions for automation without PLC. Implement simple and light automation using only RB Cobot.

## Software PLC

A simple PLC ladder can be implemented in the robot control box. You can process various input/output signals and communication signals through Software PLC Ladder.

## HMI Communication

MemoryLink communication is available for HMI devices such as ProFace and M2I. Connect the customer's preferred HMI directly to the robot.

## I/O Extension

There is a dedicated I/O expansion module, so you can increase the number of I/O through plug and play.

## AC Servo Motor Control

AC Servo Motor can be controlled by a robot without a PLC. Immediately implement horizontal rails, vertical elevators, etc.

## FANUC Communication

Supports digital communication to exchange data with FANUC CNC machines. You can easily configure CNC automation equipment.

## Customizable Hand Controller Buttons

You can assign functions you want to the buttons on the hand controller provided by the RB Series. Perform simple tasks without the need for additional button creation.

## DataBase

It has its own built-in database system, so it can store various data.

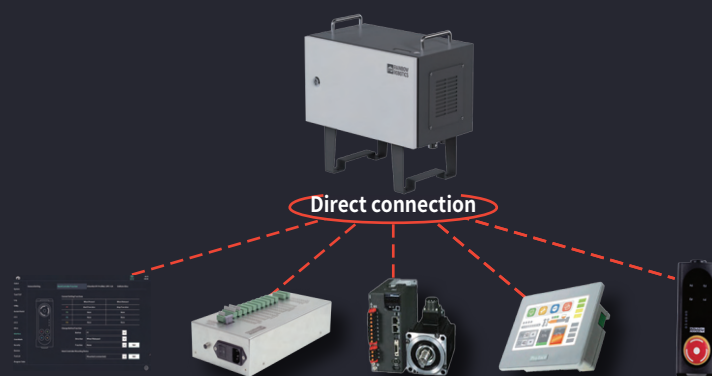

Shorten ROI time



Increase Maintenance Efficiency



Reduce Implementation Costs

## Convenient Function :Tele-Operation

# Features and Benefits of RB Cobot Software

Rainbow Robotics offers tele-operation as a default feature, enabling intuitive remote control via master-slave configuration. Operators can transmit their motions directly to the robot without additional cost, making it ideal for hazardous or hard-to-access environments.

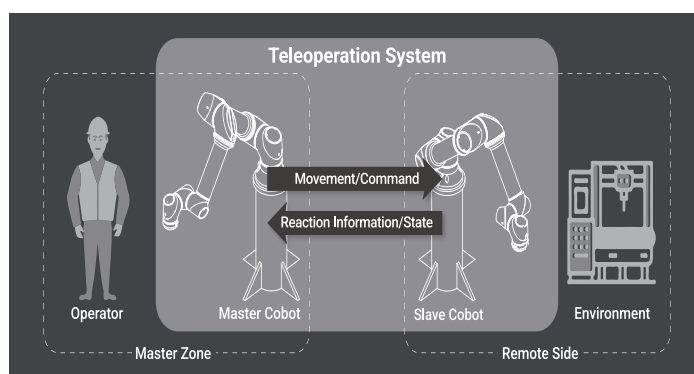

# Plug-N-Play Accessories

RB series cobots support “Plug&Play” for easier integration of a variety of peripherals. The streamlined approach accelerates the development process of versatile solutions that are compatible with diverse working conditions.

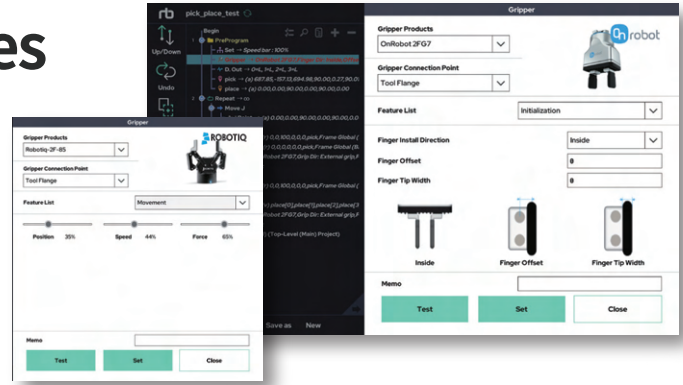



\*The intellectual property rights for the product images and logos used in this promotional material belong to the respective manufacturers.

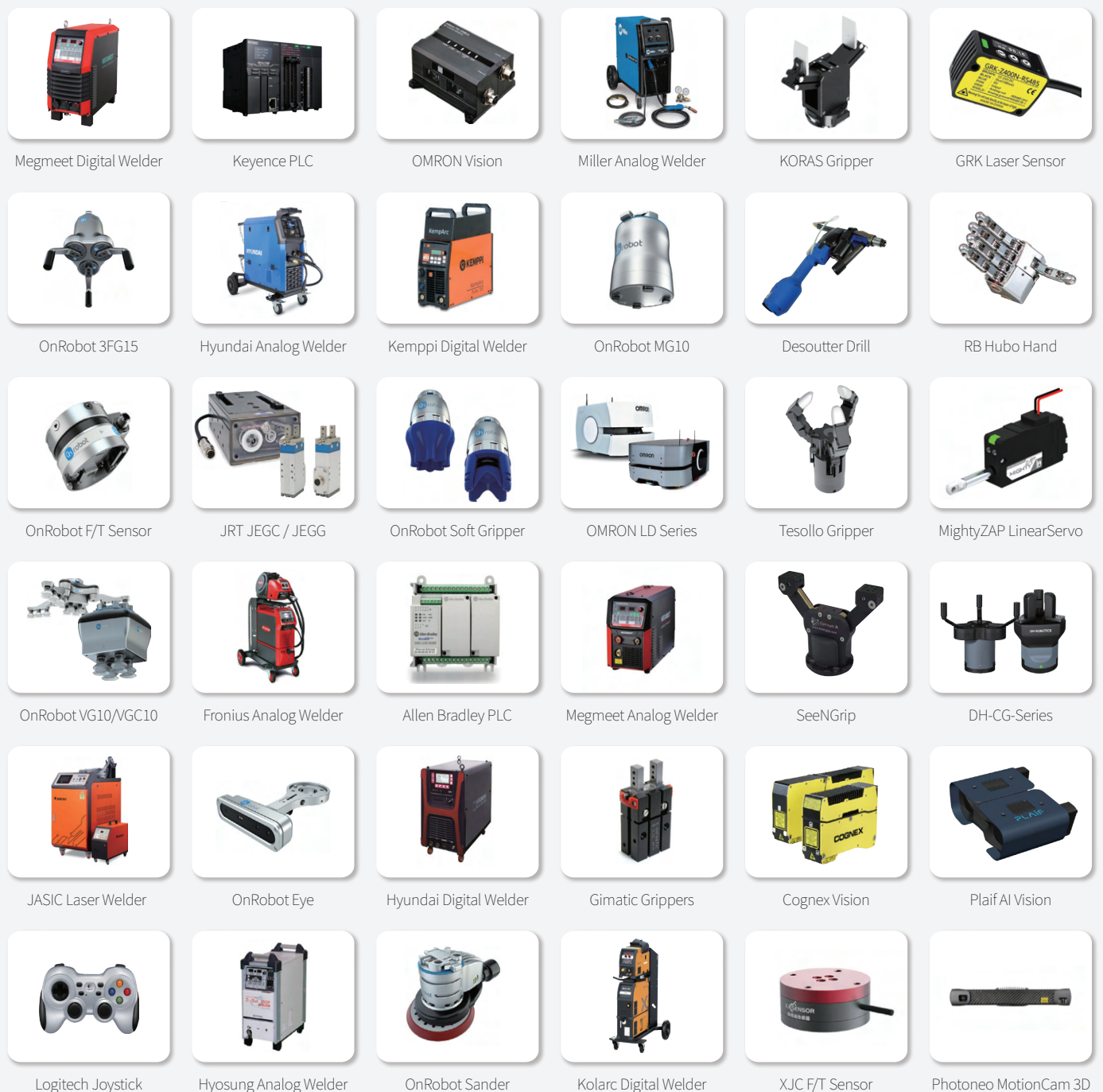

# How RB Cobots Drove Innovations in Manufacturing and Hospitality Industry

## 1 CNC machine tending

CNC machine tending involves the repetitive process of loading raw materials into a machining tool and retrieving the finished product. The RB series cobots handle these simple and repetitive tasks on behalf of human workers and mitigate the risk of industrial accidents. Additionally, RB series is IP66-rated, making it resistant to dust and water. This allows the robots to continue working seamlessly, even in contact with cutting oil and coolant during machining.



**STS PRECISION CO., LTD**

“RB series cobot transformed our manual CNC process, boosting productivity by 40% to 50%. We now meet doubled or tripled customer demands driven by the semiconductor boom. It's been a game-changer, revolutionizing our operations for success in the industry.”

## 2 Welding solutions

The RB series comes equipped with essential functions for weaving and arc welding, making it highly versatile for a range of welding applications. These include specimen welding, argon welding, weaving welding, pulse welding, arc welding, and corner welding.



**Clmind**

“Welding demands precision and attention to detail. Unlike regular industrial robots, RB series cobot simplifies the process with its direct teaching function, making inputting robot motions and points a breeze. It's like having a helpful assistant that enhances efficiency and accuracy.”



**JCT**

“We are a small manufacturing company that specializes in custom-made metal products. We found this cobot welding system ideal for our small-lot productions. It's easy to install, requires no additional devices, and doesn't need a fence around it, so it's space-efficient, too. It truly is a great option for businesses that are struggling to find skilled welders. Even novice robot operators can use cobot welding systems with ease. We are very happy with the cobot welding system and would recommend it to other businesses.”



### 3 Mold handling

RB series cobot improves safety and productivity in mold handling in injection molding machines. It ensures that parts are handled consistently and that they are not damaged during the transfer. It can also perform dangerous tasks that would otherwise require operators to put their hands into the injection molding machine to remove newly produced components.



TP Solution

“Robots are incredibly consistent, which led to a significant drop in defects and a major boost in productivity. But here’s where it gets even better: cobots go beyond that. They actually empower our workers to learn new skills. No more mundane tasks. Our workers now take control of the whole process and level up their expertise.”

### 4 Robot cafe platform

The cafes serviced by RB-series cobots operate 24/7 and are fully unmanned, handling everything from order placement to drink service. Ordering is as simple as using the kiosk, and your drink will be ready in 50 seconds or less. You can conveniently track your order status on the screen.



Yellowphant Coffee

“Yellowphant Coffee stands out from other machine-operated cafes with its wide range of offerings. These unmanned franchise locations serve robot-crafted coffee, ice cream, and a variety of soft drinks. Popular among customers in busy areas like highway rest stops and tourist attractions, notable locations include Deokpyeong Rest Area, Geumwang Rest Area, Jukjeon Rest Area, Busan Diamond Tower, Geoje Cable Car, and Daegu Aquarium.”

### 5 Fried Cooking Robot

Robert using RB series is a robot that automatically performs frying cooking tasks. It is a robot that can cook 50 baskets of fried food per hour, and not only chicken, but also fries such as French fries, corn dogs, and churros.



Robo Arete (Robert Chicken)

“All of our stores have installed a high-tech automated chicken frying system using RB cobots. These cobots not only cook the chicken but also come with safety laser scanners to keep our employees safe. We love how the AI technology optimizes the cooking process, guaranteeing that our recipes turn out exactly as intended. Our franchise owners and corporate headquarters are extremely happy with this cobot solution, especially because it helps us overcome the challenges of increasing labor costs and shortages.”

## Robot Specifications

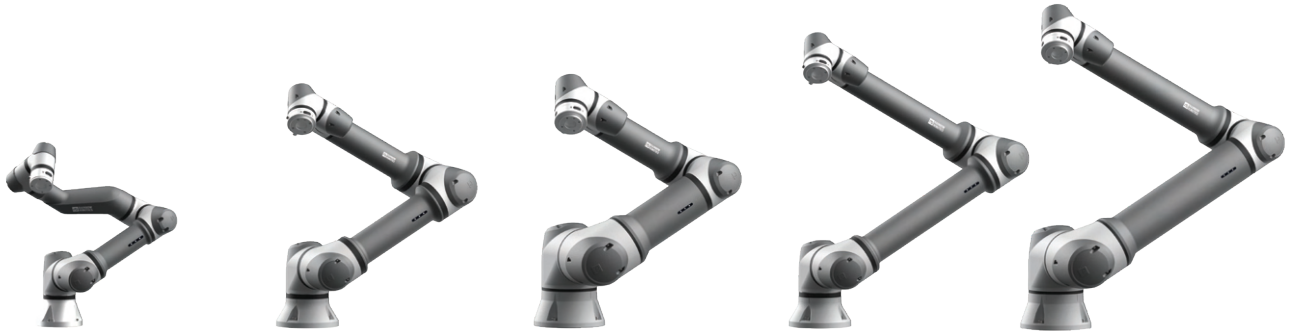

Product Name	RB3-730	RB5-850	RB16-900	RB3-1200	RB10-1300
Payload	3kg / 6.6 lbs	5kg / 11 lbs	16kg / 35.3 lbs	3kg / 6.6 lbs	10kg / 22 lbs
Reach	730mm / 28.7 in	927.7mm / 36.5 in	900mm / 35.4 in	1200mm / 47.2 in	1300mm / 51.2 in
Tool center point	630mm / 24.8 in	817mm / 31.2 in	782mm / 30.8 in	1089mm / 42.9 in	1182mm / 46.5 in
Repeatability	± 0.05mm	± 0.05mm	± 0.05mm	± 0.05mm	± 0.05mm
Footprint	Ø 128mm	Ø 173mm	Ø 196mm	Ø 173mm	Ø 196mm
Material	Aluminum, plastic steel	Aluminum, plastic steel	Aluminum, plastic steel	Aluminum, plastic steel	Aluminum, plastic steel
Tool connector type	M8 8-pin connector (12/24V, ~2A) 2EA EN ISO 9409-1-50-4-M6	M8 8-pin connector (12/24V, ~2A) 2EA EN ISO 9409-1-50-4-M6	M8 8-pin connector (12/24V, ~2A) 2EA EN ISO 9409-1-50-4-M6	M8 8-pin connector (12/24V, ~2A) 2EA EN ISO 9409-1-50-4-M6	M8 8-pin connector (12/24V, ~2A) 2EA EN ISO 9409-1-50-4-M6
Cable length	5m / 196.8 in	5m / 196.8 in	5m / 196.8 in	5m / 196.8 in	5m / 196.8 in
Weight	11kg / 24.3 lbs	22kg / 48.5 lbs	35.5kg / 78.26 lbs	22.4kg / 49.4 lbs	36.5kg / 80.47 lbs
Operating environment	IP 66 / 0-50°C	IP 66 / 0-50°C	IP 66 / 0-50°C	IP 66 / 0-50°C	IP 66 / 0-50°C
Power consumption	100 W with the ordinary program	200 W with the ordinary program	350 W with the ordinary program	200 W with the ordinary program	350 W with the ordinary program
Noise	Less than 60dB(A)	Less than 65dB(A)	Less than 65dB(A)	Less than 65dB(A)	Less than 65dB(A)
Joint range	J1: ± 360° 180°/s	J1: ± 360° 180°/s	J1: ± 360° 120°/s	J1: ± 360° 180°/s	J1: ± 360° 120°/s
	J2: ± 360° 180°/s	J2: ± 360° 180°/s	J2: ± 360° 120°/s	J2: ± 360° 180°/s	J2: ± 360° 120°/s
	J3: ± 150° 180°/s	J3: ± 165° 180°/s	J3: ± 165° 180°/s	J3: ± 165° 180°/s	J3: ± 165° 180°/s
	J4: ± 360° 180°/s	J4: ± 360° 180°/s	J4: ± 360° 180°/s	J4: ± 360° 180°/s	J4: ± 360° ± 180°/s
	J5: ± 360° 360°/s	J5: ± 360° 180°/s	J5: ± 360° 180°/s	J5: ± 360° 180°/s	J5: ± 360° 180°/s
	J6: ± 360° 360°/s	J6: ± 360° 180°/s	J6: ± 360° 180°/s	J6: ± 360° 180°/s	J6: ± 360° 180°/s

## Robot Specifications



Product Name	RB6-1700	RB20-1800	RB20-1900	RB30-1400
Payload	6kg / 13.2 lbs	20kg / 44 lbs	20kg / 44 lbs	30kg / 66.1 lbs
Reach	1700mm / 66.9 in	1800mm / 70.8 in	1900mm / 74.8 in	1400mm / 55.1 in
Tool center point	1582mm / 62.3 in	1670mm / 65.7 in	1770mm / 69.7 in	1270mm / 50 in
Repeatability	± 0.05mm	± 0.05mm	± 0.05mm	± 0.05mm
Footprint	Ø 196mm	Ø 245mm	Ø 245mm	Ø 245mm
Material	Aluminum, plastic steel	Aluminum, plastic steel	Aluminum, plastic steel	Aluminum, plastic steel
Tool connector type	M8 8-pin connector (12/24V, ~2A) 2EA EN ISO 9409-1-50-4-M6	M8 8-pin connector (12/24V, ~2A) 2EA EN ISO 9409-1-80-6-M8	M8 8-pin connector (12/24V, ~2A) 2EA EN ISO 9409-1-80-6-M8	M8 8-pin connector (12/24V, ~2A) 2EA EN ISO 9409-1-80-6-M8
Cable length	5m / 196.8 in	5m / 196.8 in	5m / 196.8 in	5m / 196.8 in
Weight	39kg / 86 lbs	70.5kg / 155.4 lbs	75kg / 165.3 lbs	71.68kg / 158 lbs
Operating environment	IP 66 / 0-50°C	IP 66 / 0-50°C	IP 66 / 0-50°C	IP 66 / 0-50°C
Power consumption	350 W with the ordinary program	500 W with the ordinary program	500 W with the ordinary program	500 W with the ordinary program
Noise	Less than 65dB(A)	Less than 65dB(A)	Less than 65dB(A)	Less than 65dB(A)
Joint range	J1: ± 360° 120°/s J2: ± 360° 120°/s J3: ± 165° 180°/s J4: ± 360° 180°/s J5: ± 360° 180°/s J6: ± 360° 180°/s	J1: ± 360° 120°/s J2: ± 360° 120°/s J3: ± 165° 120°/s J4: ± 360° 180°/s J5: ± 360° 180°/s J6: ± 360° 180°/s	J1: ± 360° 120°/s J2: ± 360° 120°/s J3: ± 150° 120°/s J4: ± 360° 120°/s J5: ± 360° 180°/s J6: ± 360° 180°/s	J1: ± 360° 120°/s J2: ± 360° 120°/s J3: ± 150° 120°/s J4: ± 360° 120°/s J5: ± 360° 180°/s J6: ± 360° 180°/s



World's First  
**NSF-Certified Cobot**

**RBN**  
SERIES

NSF / ANSI 169



The RBN Series has been certified by NSF International for safe and hygienic use in the food and beverage industry.

Designed for standalone operation, the RBN Series requires no protective jackets or external accessories.

The RBN Series is available in three models: **RB5-850EN, RB3-1200EN, and RB10-1300EN** and is suited for demanding F&B environments such as high-temperature deep fryers and high-pressure espresso machines.

\* The specifications of the RBN Series robots are identical to those of the standard RB Series robots.

### ✓ NSF Certified

- Certified to NSF/ANSI 169 standards for Special Purpose Food Equipment and Devices
- Approved for food production facility use

### ✓ Food-safe Cobot

- Coated with non-toxic, food-grade paint
- Certified for use in food production environments (Food Zone – No Direct Contact)
- Successfully passed impact tests, with no harmful substances detected upon impact.

### ✓ Durable Components

- Rust-resistant SUS fasteners and connection components
- Proven durability through extensive validation in real manufacturing environments.

### ✓ Enhanced User Experience

- IP66 protection eliminates the need for protective jackets.

## NSF Certificate and scope of application



### F&B Applications

- Unmanned robot cafés & bars (programmable recipes: bubble tea, cocktails, craft coffee, and more)
- Ice cream robots, waffle-making robots
- Chicken preparation robots
- Automated noodle cooking robots, and more



Certification Body | NSF International

Certification Type	Product	Applied Standard
NSF	Collaborative Robot Arm	NSF/ANSI 169: Special Purpose Food Equipment and Devices

# Specifications

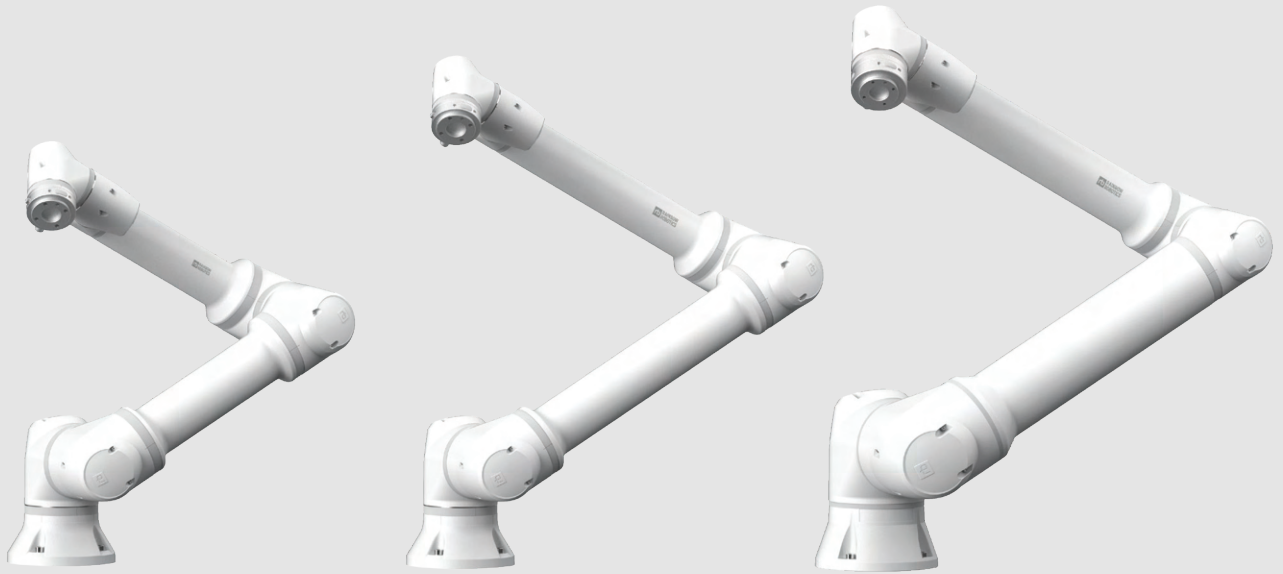

Product name	RB5-850EN	RB3-1200EN	RB10-1300EN
<b>Payload</b>	5kg / 11 lbs	3kg / 6.6 lbs	10kg / 22 lbs
<b>Reach</b>	927.7mm / 36.5 in	1200mm / 47.2 in	1300mm / 51.2 in
<b>Toll center Point</b>	817mm / 31.2 in	1089mm / 42.9 in	1182mm / 46.5 in
<b>Repeatability</b>	± 0.05mm	± 0.05mm	± 0.05mm
<b>Footprint</b>	Ø 173mm	Ø 173mm	Ø 196mm
<b>Material</b>	Aluminum, Plasticm, steel	Aluminum, Plasticm, steel	Aluminum, Plasticm, steel
<b>Tool connector type</b>	M8 8-pin connector (12/24V, ~2A) 2EA EN ISO 9409-1-50-4-M6	M8 8-pin connector (12/24V, ~2A) 2EA EN ISO 9409-1-50-4-M6	M8 8-pin connector (12/24V, ~2A) 2EA EN ISO 9409-1-50-4-M6
<b>Cable length</b>	5m / 196.8 in	5m / 196.8 in	5m / 196.8 in
<b>Weight</b>	22kg / 48.5 lbs	22.4kg / 49.4 lbs	36.5kg / 80.47 lbs
<b>Operating environment</b>	IP 66 / 0-50°C	IP 66 / 0-50°C	IP 66 / 0-50°C
<b>Power consumption</b>	200 W with the ordinary program	200 W with the ordinary program	350 W with the ordinary program
<b>Noise</b>	Less than 65dB(A)	Less than 65dB(A)	Less than 65dB(A)

※ The specifications of the RB-N series robots are identical to those of the RB series robots.



---

**Head office**

8, Jiphyeonjungang 3-ro  
Sejong-si, Republic of Korea

---

**AI Research Lab**

RM 206, 27, Geumto-ro 80beon-gil  
Sujeong-gu, Seongnam-si, Gyeonggi-do, Republic of Korea

---

**USA Branch**

3550 Salt Creek Lane, Suite-110  
Arlington Heights IL 60005, USA

---

**Purchase Inquiry  
Technical Support  
Website  
General**

[sales@rainbow-robotics.com](mailto:sales@rainbow-robotics.com)  
[support@rainbow-robotics.com](mailto:support@rainbow-robotics.com)  
[www.rainbow-robotics.com](http://www.rainbow-robotics.com)  
[rainbow@rainbow-robotics.com](mailto:rainbow@rainbow-robotics.com)